



PIPE EQUIPMENT SPECIALISTS

PREP 4 PIPE BEVELLING 1" to 4"



SCAN QR CODE
TO WATCH VIDEO



TAG **PREP 4**
Portable Pipe Beveling Machine

RANGE: 23 - 112mm i/d / 1 - 4" i/d

- **Functions:** External beveling / internal beveling / elbow and fittings beveling / facing / counter-boring / weld removal / J-prepping and facing of tube plate
- **Materials:** Any kind of steel and exotic alloy
- **Power:** Pneumatic, electric or battery (110v or 220v)

The PREP 4 is one of our most popular i/d locking, in-line feed end prep machines. The PREP 4's power to weight ratio, in electric, battery (110v or 220v), or pneumatic drive form is unrivalled. A 4-jaw tool holder (chuck) allows use of up to 4 insert or form tools to enable beveling of heavy wall pipe and tube, simultaneous external, internal and facing of tubes can be performed with ease for accurate repetitive work. Its size, power, and functionality, makes it extremely popular in high volume boiler repair and maintenance work, tube facing, weld removal, and J-prepping of the tube plate.



FEATURES AND ADVANTAGES

The PREP 4 is torque reactive. This means that the pipe or tube does not have to be fixed to be bevelled, making it particularly useful on-site, in maintenance and repair situations. This is due to the design and strength of the thru shaft system that locks to the bore of the pipe.

The jaw system itself consists of 3 equilateral positioned machined jaw segments, retained and locked on an inner, 'grooved' expansion shaft.

These grooves keep the jaws held securely in position, unlike other systems that use a metal or rubber bands for jaw retention.

As the expansion nut is tightened, the jaws expand, locking tightly, and square to the bore of the pipe.



 **MADE IN UK** 

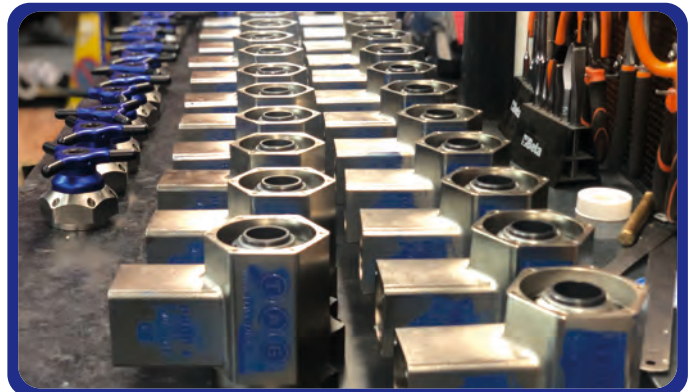

POWER OPTIONS:

PNEUMATIC



PART NO. TP4P

ELECTRIC



PART NO. TP4E110 / TP4E220

BATTERY



PART NO. TP4B110 / TP4B220

ACCESSORIES AND OPTIONS:

ELBOW / FITTINGS SHAFT

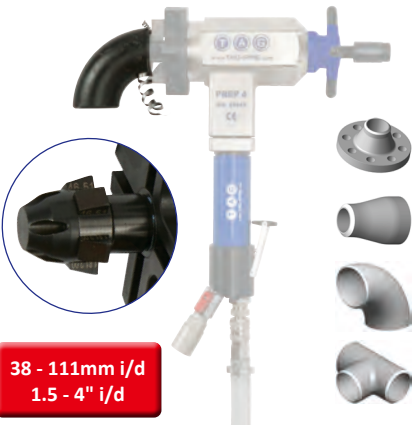

38 - 111mm i/d
1.5 - 4" i/d

PART NO. TP4ESKV2

AUTO LOCK

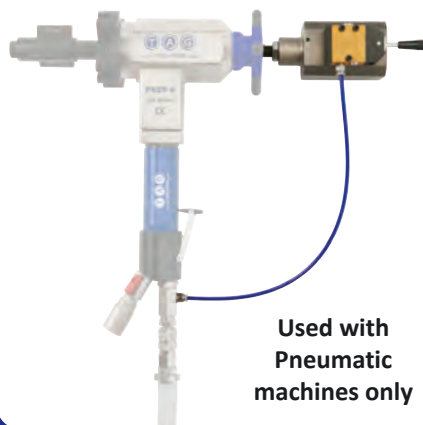

Used with
Pneumatic
machines only

PART NO. TP4ALD

RATCHET HANDLES



PART NO. TP4RHKV2

FILTER LUBRICATOR



PART NO. AFL1



PREP 4 TECHNICAL FEATURES

DESCRIPTION	MEASUREMENT	PNEUMATIC	ELECTRIC	BATTERY
Part Number	n/a	TP4P	TP4E110 / TP4E220	TP4B110 / TP4B220
Locking tube range	mm (i/d)	23 - 112	23 - 112	23 - 112
Locking tube range	inch (i/d)	1 - 4"	1 - 4"	1 - 4"
Idle speed	rpm	5 - 100	5 - 82	23 / 37 / 50
Torque	N m	176	152	140
Length of axial feed	mm	40.5	40.5	40.5
Max operating temperature	°C	55	55	55
Max acoustic radiation	dB	75	75	75
Pneumatic motor power	hp	1.35	n/a	n/a
Air consumption	cfm / l/min.	36 / 1020	n/a	n/a
Air working pressure	psi / bar	90 / 6.5	n/a	n/a
Air hose connection	inches	½"	n/a	n/a
Electric motor power	watt	n/a	1300	800
Voltage	volt	n/a	110 or 220	Charger 110 or 220
Frequency	Hz	n/a	50 / 60	Charger 50 / 60
Unit weight	kg / lbs	9.4 / 20.7	10.4 / 23	11.1 / 24.5
Packing dimensions	mm	640 x 500 x 140	640 x 500 x 140	640 x 640 x 140
Packing weight	kg / lbs	28.5 / 63	29.5 / 65	30.5 / 67

Our group policy is one of continuous improvement. Products and data tables are subject to change or vary from those illustrated.

- All units are supplied complete with all gripping segments to cover the full range of the machine. Service tools, drawings, instruction manual and warranty certificate are also supplied as standard.
- Each machine is supplied with a protective custom built metal box.
- Pneumatic machine must be used with filter lubricator and oil - use without will void warranty.



DIMENSIONS

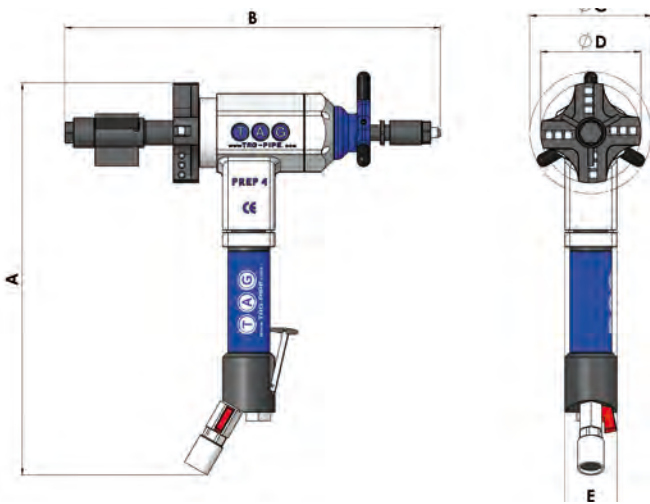

DIM	PNEUMATIC	ELECTRIC	BATTERY
A	455mm	510mm	540mm
B	434mm	434mm	434mm
∅C	140mm	140mm	140mm
∅D	115mm	115mm	115mm
E	60mm	90mm	90mm

EXAMPLES OF COMMON CUTTING TOOLS

FORMED TOOLS

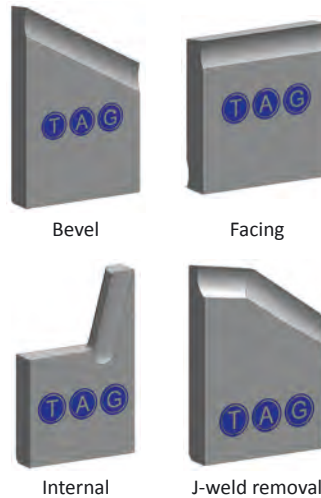

HOLDER / INSERT

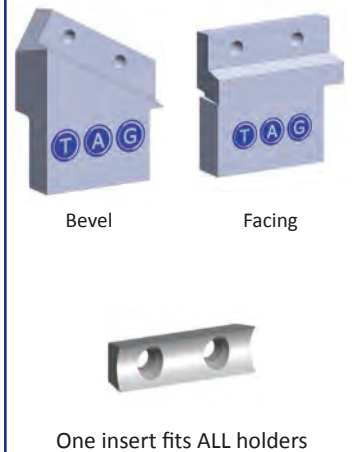

All shapes, sizes and angles available



SPECIALIZED FABRICATION EQUIPMENT GROUP

Global Locations:

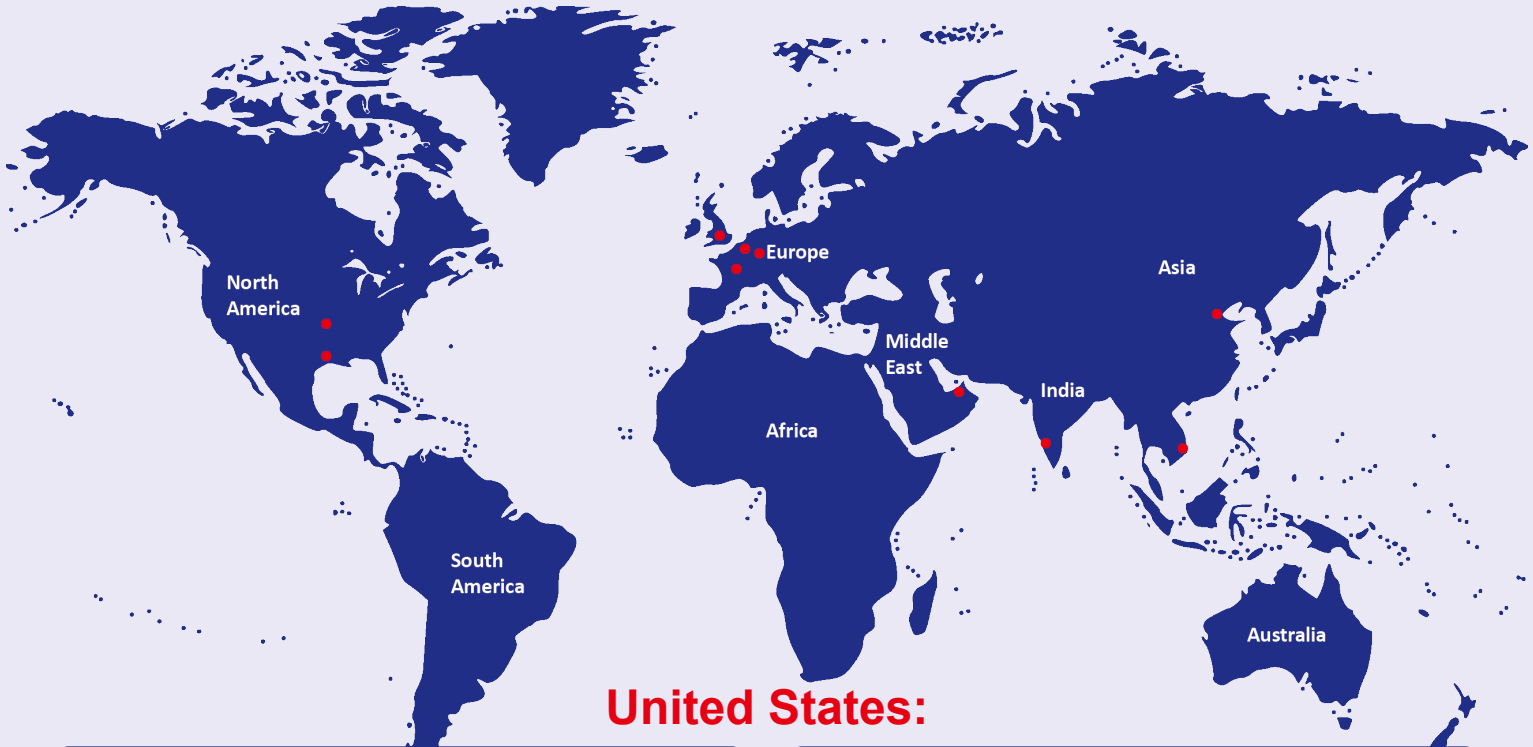

United States:

SFE HOUSTON

SPECIALIZED FABRICATION EQUIPMENT GROUP

4433 South Dr, Houston,
Texas 77053, USA

Tel: +1 713 747 8502

E-mail: sales@sfe-brands.com

SFE TULSA

SPECIALIZED FABRICATION EQUIPMENT GROUP

7136 South Yale Ave, Tulsa,
Oklahoma 74136, USA

Tel: +1 713 747 8502

E-mail: sales@sfe-brands.com

International:

SFE UNITED KINGDOM

SPECIALIZED FABRICATION EQUIPMENT GROUP

Unit 15 & 16 Grendon Industrial Estate,
Grendon Underwood, Aylesbury,
Buckinghamshire, HP18 0QX England

Tel: +44 (0)1869 324 144

E-mail: sales-int@sfe-brands.com

SFE BELGIUM

SPECIALIZED FABRICATION EQUIPMENT GROUP

Mosten 13, 9160 Lokeren
Belgium

Tel: +44 (0)7741 551536

E-mail: sales-belgium@sfe-brands.com

SFE FRANCE

SPECIALIZED FABRICATION EQUIPMENT GROUP

Acces bureau, 34 Rue du Docteur Abel,
26000 VALENCE, France

Tel: +44 (0)7741 872489

E-mail: sales-france@sfe-brands.com

SFE GERMANY

SPECIALIZED FABRICATION EQUIPMENT GROUP

Am Güterbahnhof 1, 77694 Kehl am Rhein,
Germany

Tel: +49 (0)7851 9553507

Mob: +44 (0)7741 872489

E-mail: sales-germany@sfe-brands.com

SFE MIDDLE EAST

SPECIALIZED FABRICATION EQUIPMENT GROUP

Al Ittihad Street, P.O. Box 3763
Dubai, United Arab Emirates

Tel: +971 (0)50 217 1376

E-mail: sales-me@sfe-brands.com

SFE INDIA

SPECIALIZED FABRICATION EQUIPMENT GROUP

Plot No. PAP 3, D 3 Block,
Chinchwad, Pune 411 019

Mob: +91 90 1102 4332

Mob: +91 95 5258 4361

E-mail: sales-india@sfe-brands.com

SFE ASIA

SPECIALIZED FABRICATION EQUIPMENT GROUP

Emerald Block A, No.2, Road N4, Son Ky Ward,
Tan Phu District, Ho Chi Minh, Vietnam.

Tel: 0919.517.01

E-mail: sales-asia@sfe-brands.com

Copyright © 2021 Specialized Fabrication Equipment Group, All rights reserved.

OUR BRANDS



PIPE EQUIPMENT SPECIALISTS

